

Seal House Ltd

Profile Selection Chart

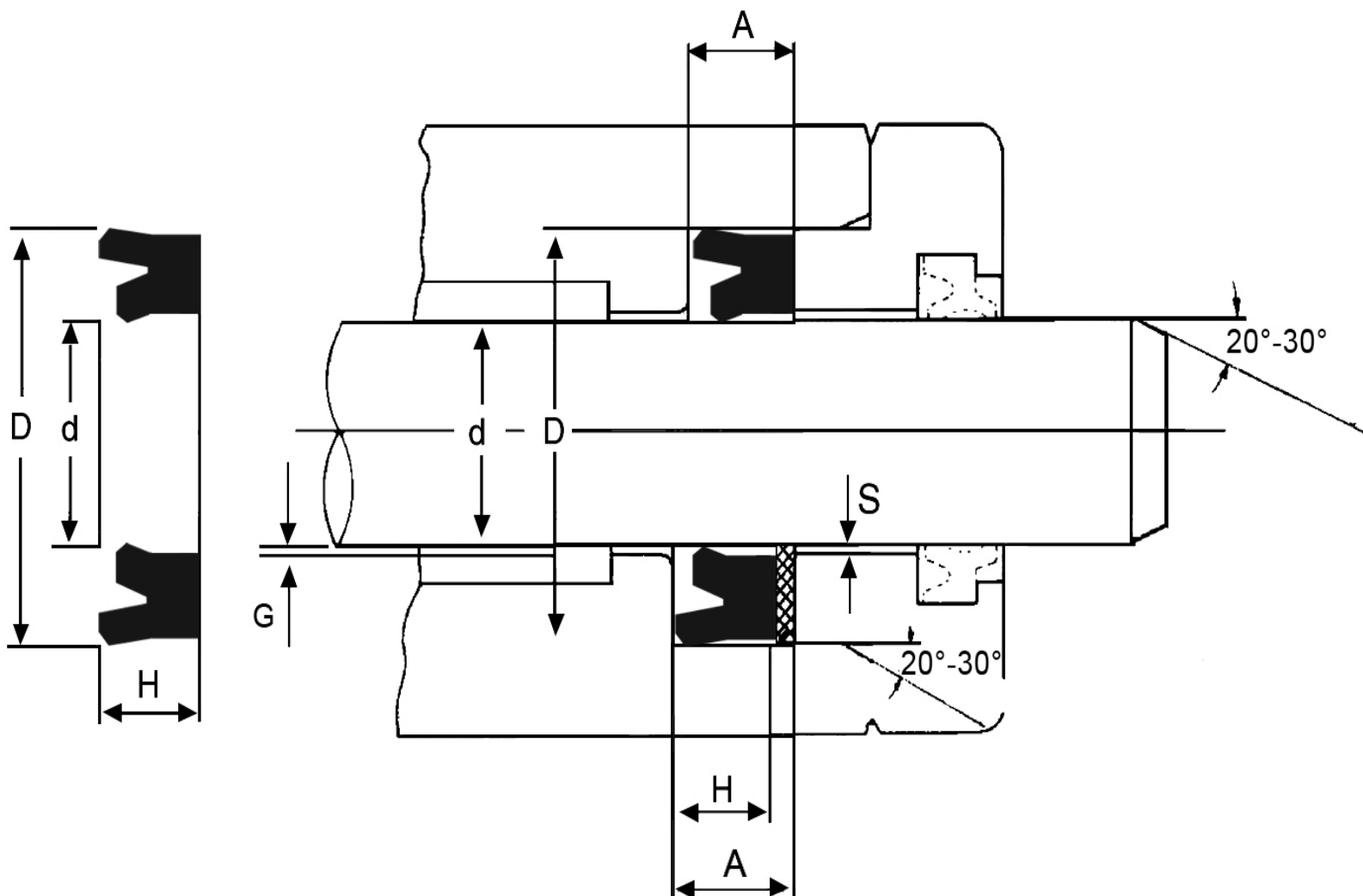

Click on one of the choices below

1. Wipers

All the wiper profiles can be modified to suit your specific requirements

2. Guide Rings

All the guide rings profiles can be modified to suit your specific requirements

3. Piston Seals

All the piston seals profiles can be modified to suit your specific requirements

4. Rotary Seals

All the rotary seal profiles can be modified to suit your specific requirements

5. Rod Seals

All the rod seal profiles can be modified to suit your specific requirements

6. Back-Ups

All the back-up profiles can be modified to suit your specific requirements

A25-F

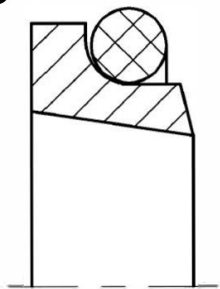

A26-F

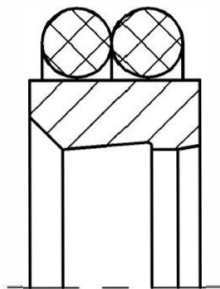

A27-F

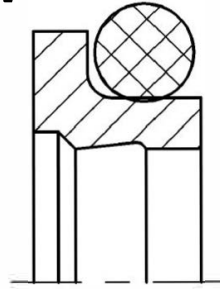

2. Guide Rings

Fo1

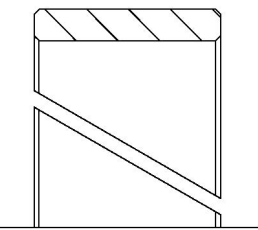

Fo2

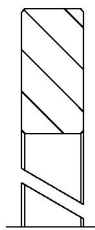

Fo3

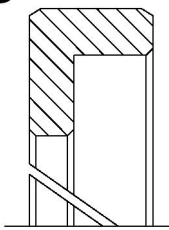

Fo4

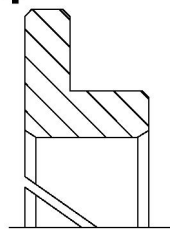

Fo5

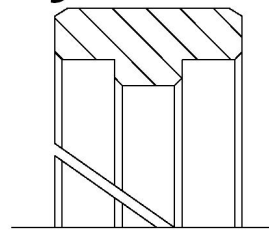

Fo6

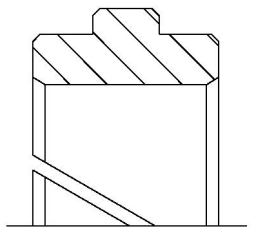

Fo7

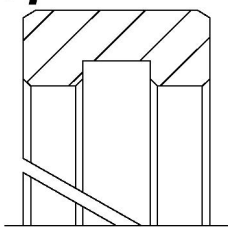

Fo8

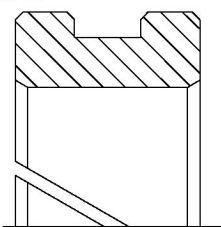

3. Piston Seals

Ko1-P

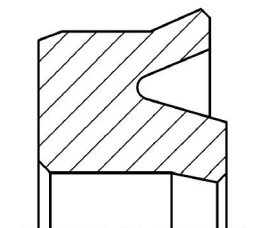

Ko1-R

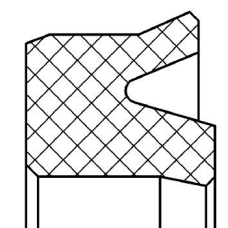

Ko2-P

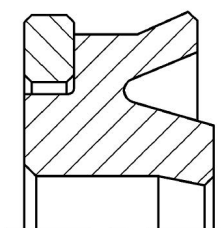

Ko2-PD

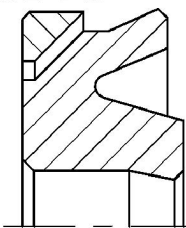

Ko2-R

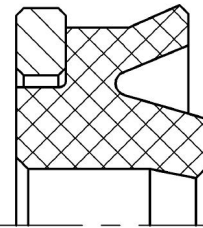

Ko2-RD

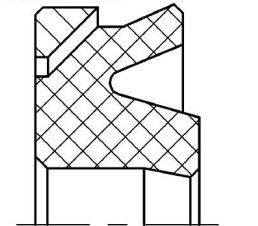

Ko3-F

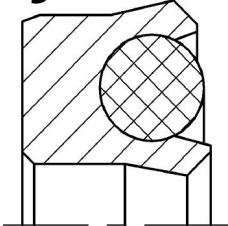

Ko3-P

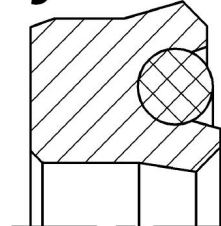

Ko3-S

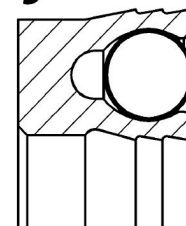

Ko4-P

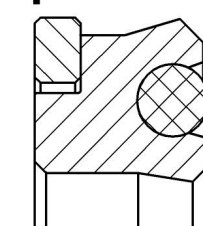

Ko4-PD

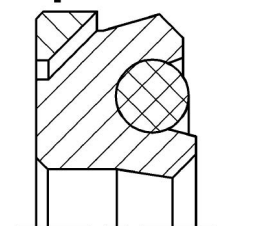

Ko5-P

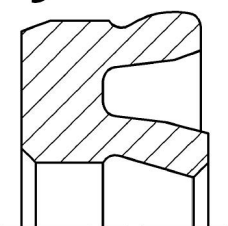

Ko5-R

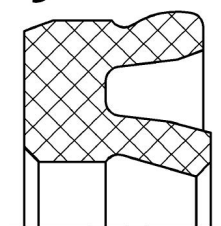

Ko6-P

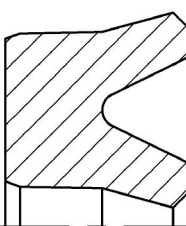

Ko6-R

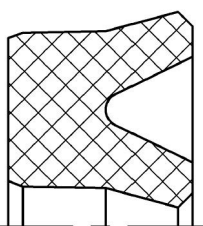

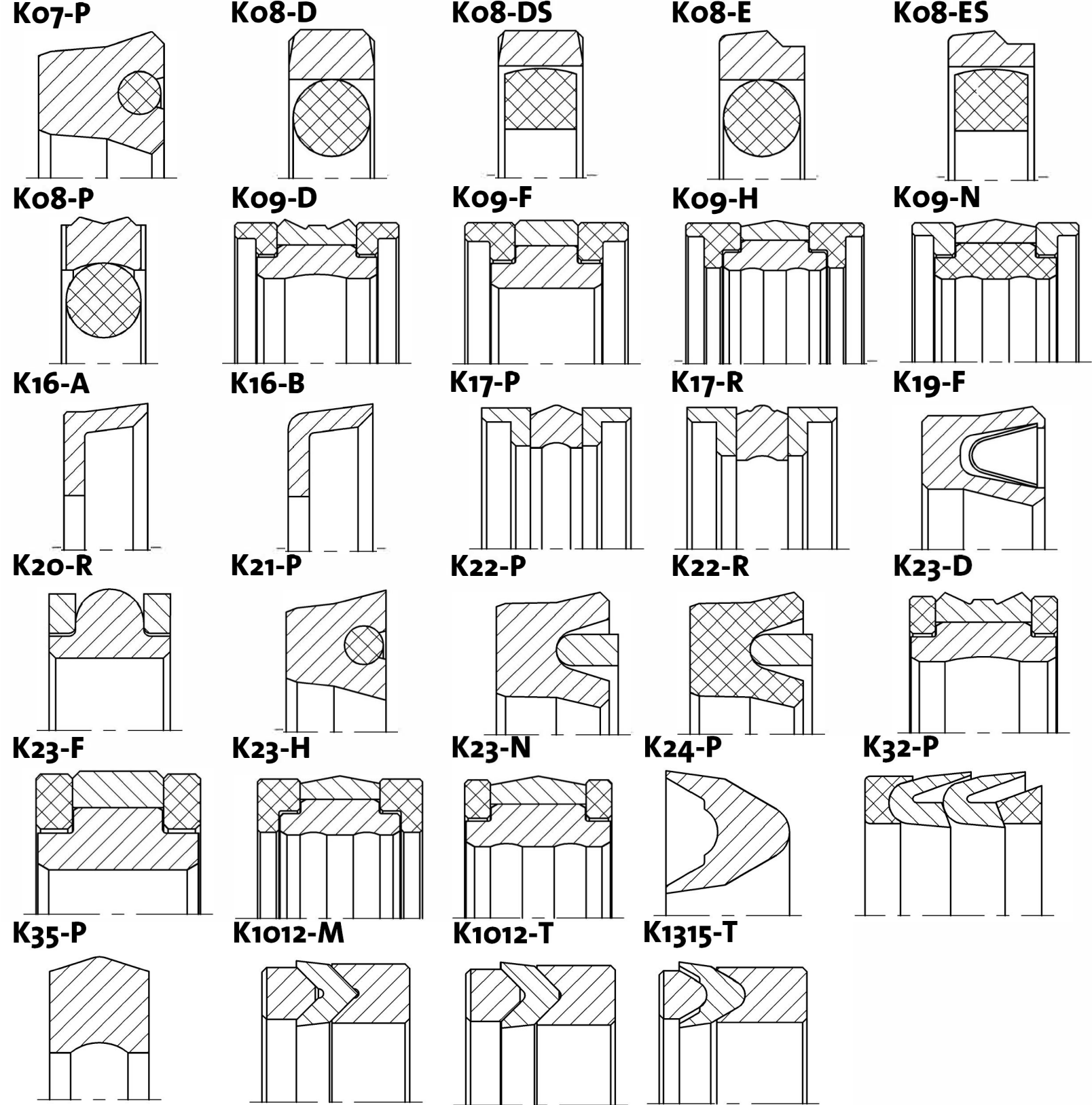

4. Rotary Seals

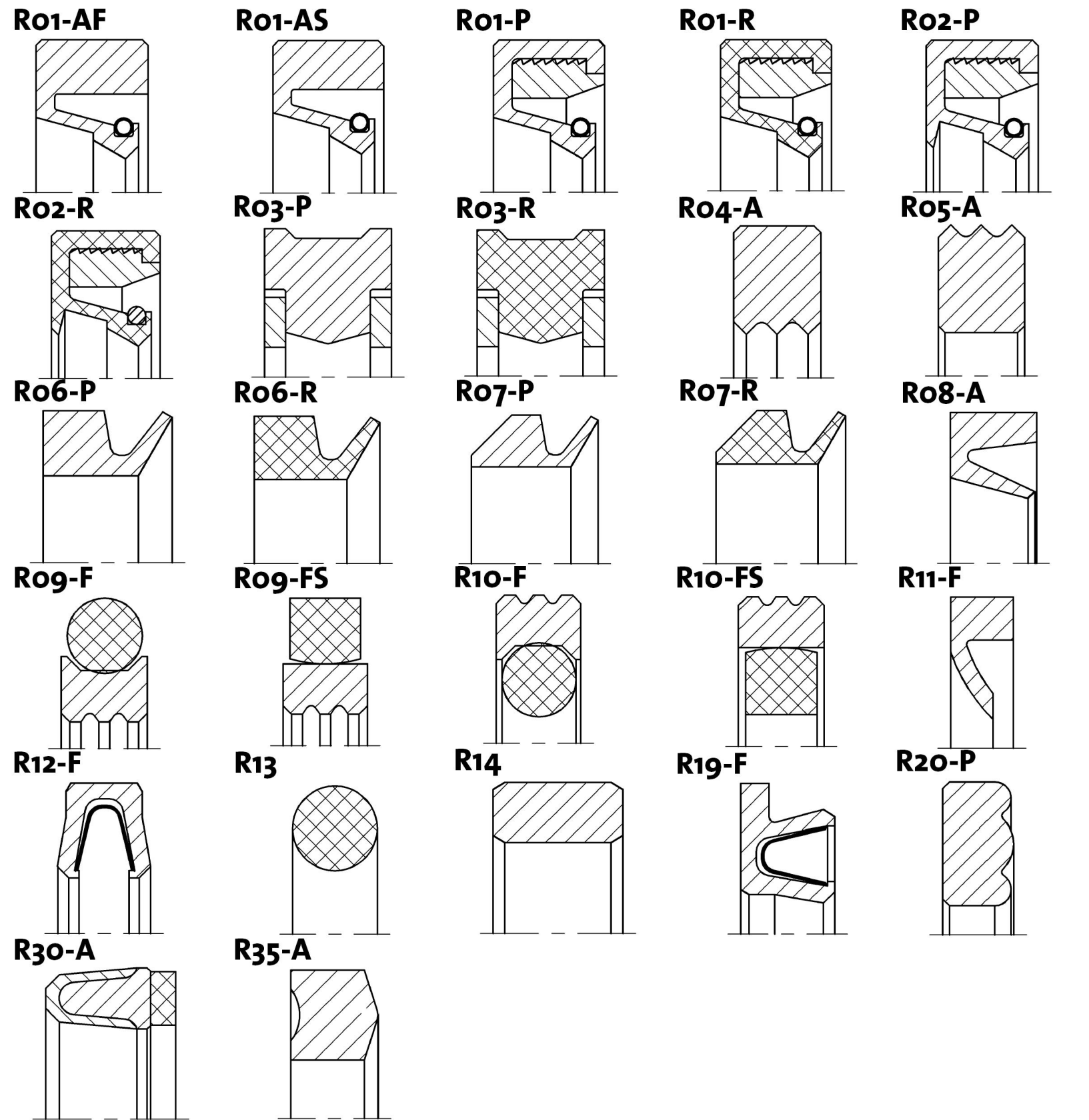

5. Rod Seals

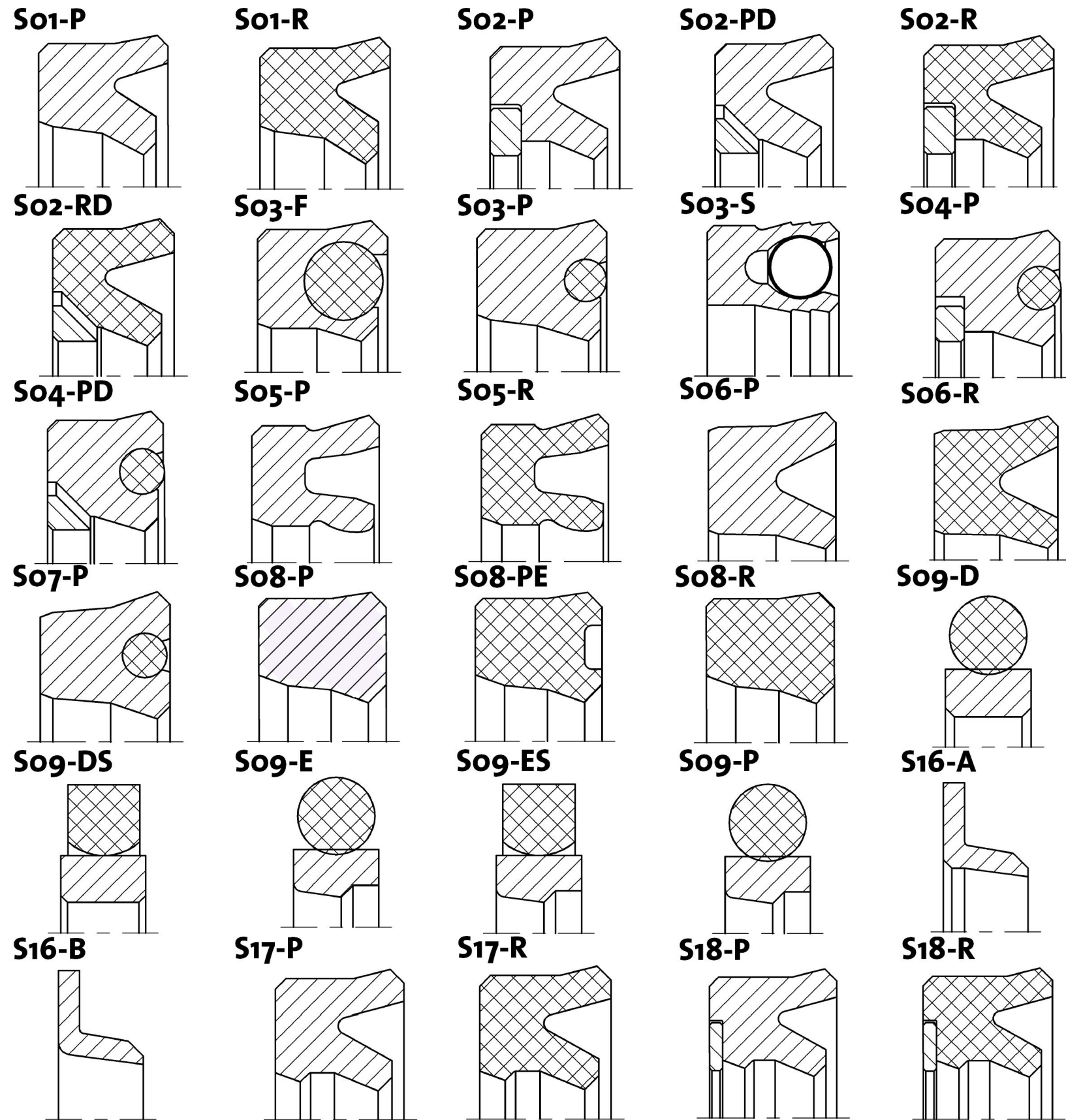

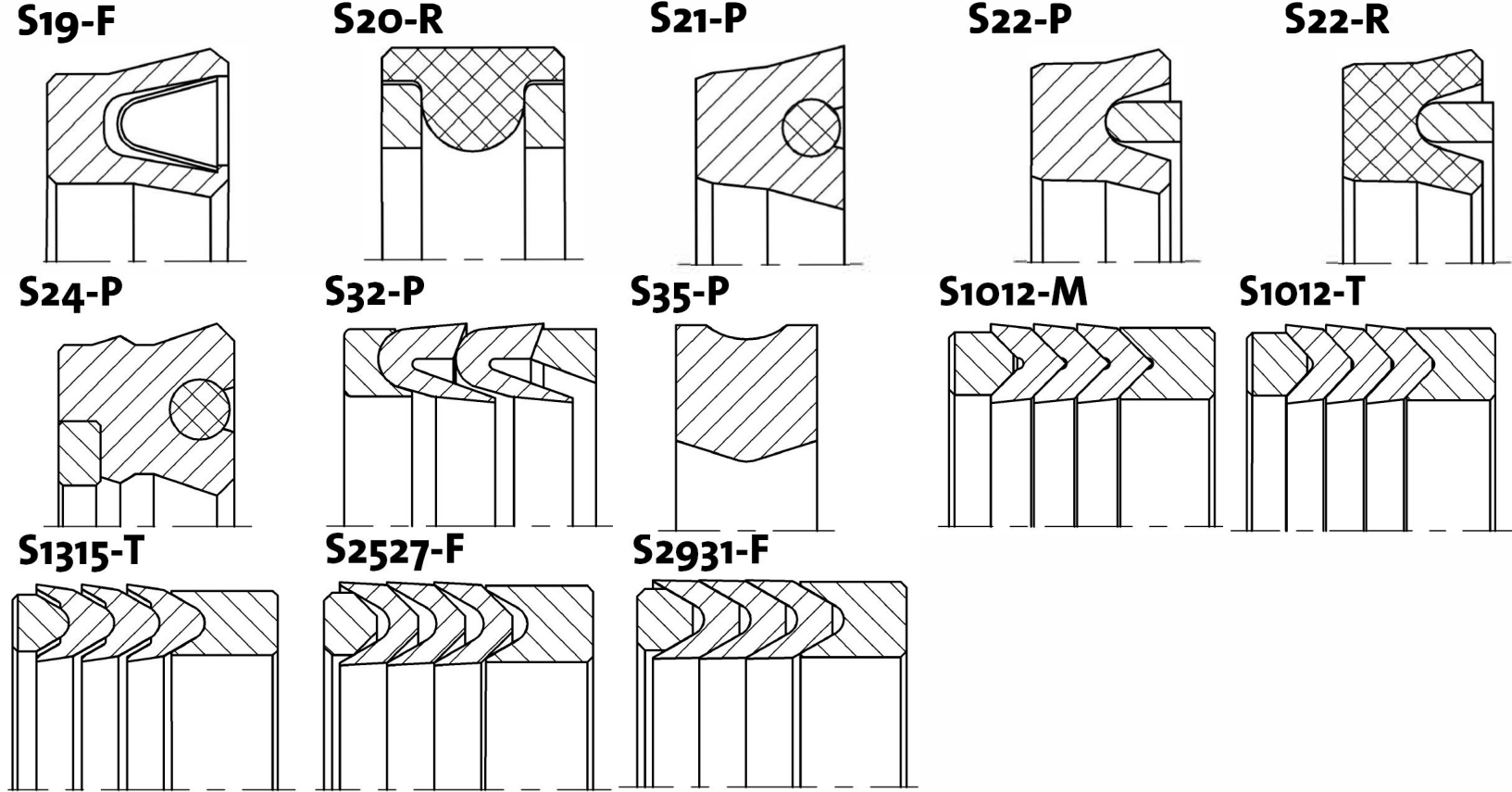

6. Back-Ups

